



OPERATING INSTRUCTIONS

SAFE LOCK PAXOS ADVANCE WITH ROTARY KNOB, DUAL LOCK

Electronic safe lock for WA safes and reinforced doors

Many thanks!

Many thanks for choosing Waldis to give you the security you want.

The safe you have decided to purchase is a product tested in compliance with the EN1143-1 standard. A Swiss quality product with security tested by the VdS (German Association of Indemnity Insurers).

Before starting to use your strongbox, please read these instructions thoroughly!

Your contact in case of questions:

WALDIS Tresore AG

Hofwissenstrasse 20

CH-8153 Rümlang

Telephone: +41 43 211 12 00

Fax: +41 43 211 12 12

Email: info@tresore.ch

Table of contents

1. Overview	1
1.1. Operating controls: WALDIS First and Premium	1
1.2. Description of operating controls.....	2
1.3. Functions of the rotary knob	2
2. Starting to use your safe.....	3
3. Operation	5
3.1. Opening the safe	5
3.2. Locking the safe.....	6
3.3. Opening the safe under threat	6
3.4. Reprogramming codes	7
3.4.1. User code 01 (OCa1) and user code 02 (OCb1) for lock 1.....	7
3.4.2. User code 01 (OCa2) and user code 02 (OCb2) for lock 2.....	8
3.4.3. Master code 00 (MA1).....	9
3.4.4. Master code 00 (MA2).....	9
3.5. Setting the date and time	10
3.6. Replacing the battery	10
4. Malfunctions.....	11
4.1. Battery.....	11
4.2. Tamper block	12
5. Assignment of connections on the I/O box.....	12
5.1. Assignment of terminals on the I/O box.....	12
5.2. Connection data for the I/O box	13
6. Basic rules for secure codes.....	16

1. Overview

The Paxos Advance is installed in the WALDIS First and WALDIS Premium series of models, and in WG 9 reinforced doors. Because of their high security class, this is the only lock that can be installed in these series of models. Users find that the display makes it easy and clear to operate. Various additional functions can also be used with the Paxos Advance.

1.1. Operating controls: WALDIS First and Premium

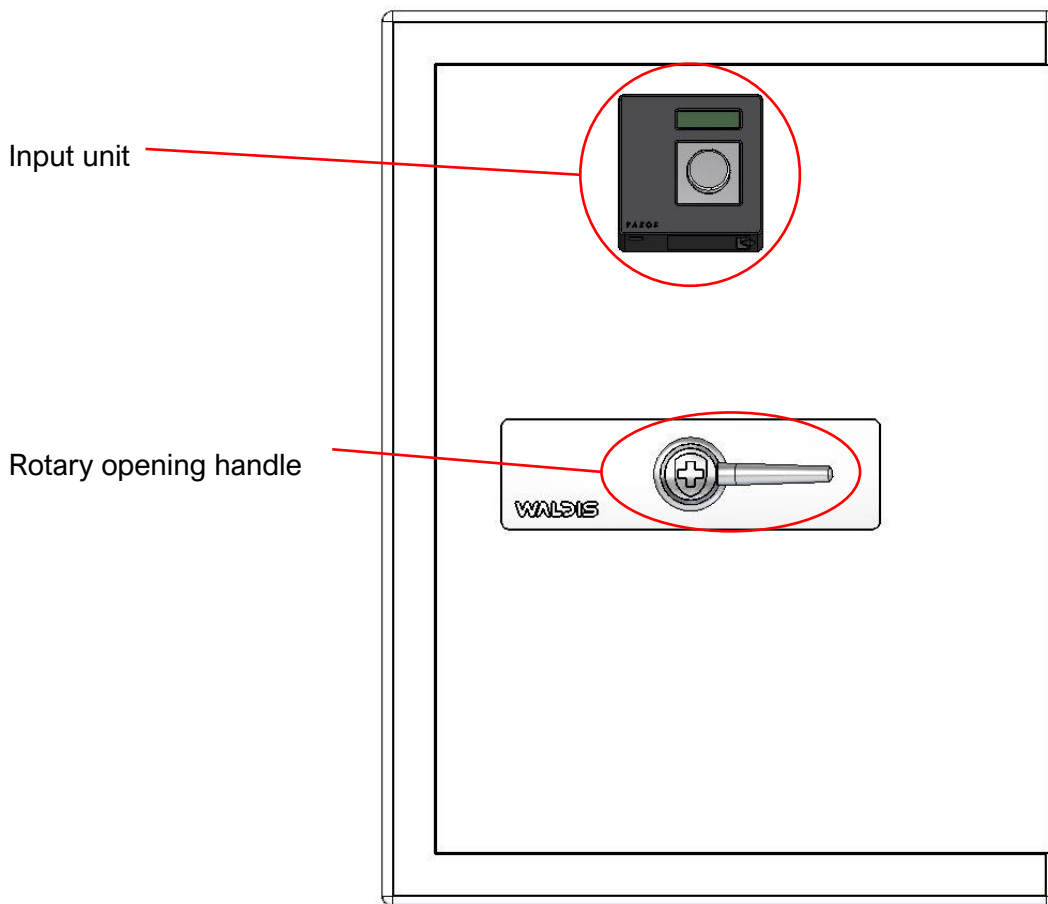

NOTE: These operating instructions describe how to handle a safe; in each case, they show a version with the hinge on the right-hand side of the door. If you have a safe with the hinge on the left-hand side of the door, you need to perform all the turning, opening and closing movements in the opposite direction!

1.2. Description of operating controls

Pos. 1 = LCD display	Menu and input display
Pos. 2 = Rotary knob	Input and selection
Pos. 3 = USB port	Connection for computer with programming software
Pos. 4 = Battery case	

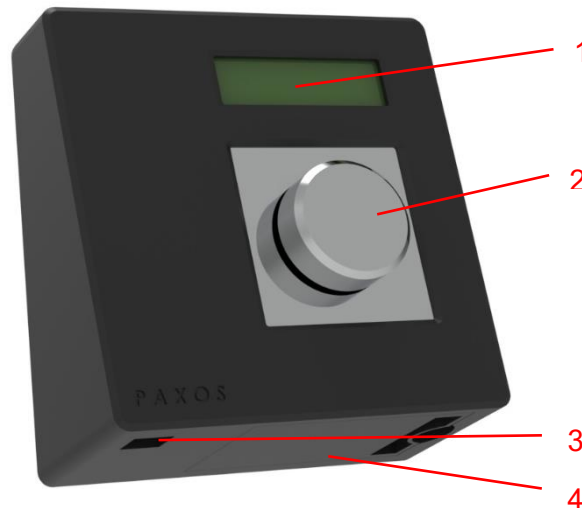

1.3. Functions of the rotary knob

Rotary knob command:

Press the rotary knob briefly.



Press the rotary knob > 1.5 seconds.



Turn the rotary knob to the left or right.



Press the rotary knob and keep it pressed down. As soon as the "Info" menu appears, release the rotary knob.



Function:

- Confirm inputs
- Call up the user menu from the standard operating display
- Delete inputs
- Cancel a function
- Go back to the previous menu level
- Select the next or previous menu item
- Select the next or previous input value
- Increase or decrease the displayed value
- Call up the "Info" menu

2. Starting to use your safe

As soon as the safe has been delivered and correctly anchored, you can start operating the lock and using the safe.

To do so, please keep to the following procedure:

1. Check that the rotary opening handle is in the 'closed' position. Do this by applying gentle pressure to move the rotary opening handle counterclockwise into the end position.
2. Use your finger to release the battery case that is slotted into the input unit from below, and swivel it downwards and outwards.



3. The battery holder (B) is inserted in the battery case; release it from the case, and fit six 1.5 V AA alkaline batteries (LR6, E91 or AM3) into it. As an option, you can also insert a rechargeable battery pack (A) from Dorma Kaba; in this case, there is no need for the battery holder.

→ Operation with rechargeable batteries is only possible with an external power supply.

Pay attention to the polarity of the

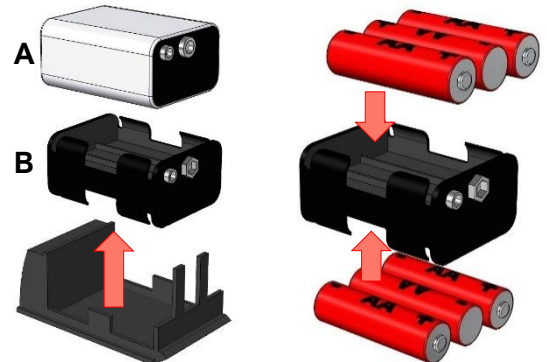

4. Carefully re-insert the battery holder (B) or the rechargeable battery pack (A) into the battery case.

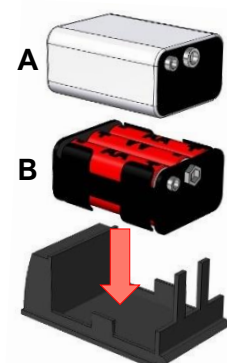

- Carefully re-insert the battery case and swivel it upwards into the housing of the input unit until the battery housing clicks into place.

As soon as the input unit is supplied with power, the display shows one of these messages: "Battery case was open, battery inserted" or "Battery case was open, rechargeable battery pack inserted".



- To delete the battery message, you must first press the rotary knob and then enter the master code (MA1) or the battery code (11111111). The lock can then be used again in the normal way.
- Press the rotary knob, and the display will show the "Date, time saved" message.
- Press the rotary knob repeatedly, and the display will show the "Open menu" message; confirm this by pressing the rotary knob again.
- The display shows the "Lock code 1" message to indicate that user code 1 or 2 for lock 1 (**11223310** or **11223320**) must be entered. If the code was entered correctly, the display shows the "Lock 1 is opening" message, followed by "Lock is opened". The display then shows the "Lock code 2" message to indicate that user code 1 or 2 for lock 2 (**12223310** or **12223320**) must be entered. If the code was entered correctly, the display shows the "Lock 2 is opening" message, followed by "Locks are open, open bolts". The rotary opening handle can only be moved clockwise after the second "Open bolts" message.

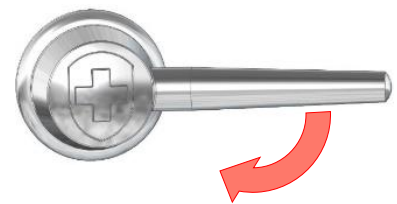
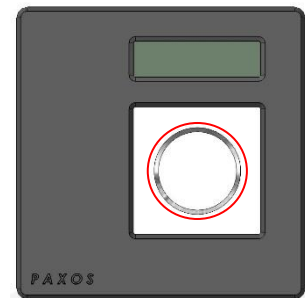

-
-
-
-
-
-
-
-
-
-
- Open the door (display shows "Released").

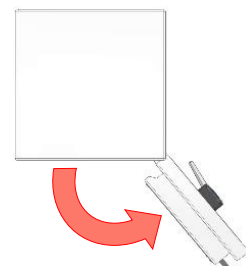

- Programme the new code as per section 3.4.

3. Operation

3.1. Opening the safe

1. First, press the rotary opening handle counterclockwise into the "closed" position to make sure that the lock bolt is relieved of pressure.
2. Press the rotary knob, and the display will show the "Date, time saved" message.
3. Press the rotary knob repeatedly, and the display will show the "Open menu" message; confirm this by pressing the rotary knob again.
4. The display shows the "Lock code 1" message to indicate that user code 1 or 2 for lock 1 (**11223310** or **11223320**) must be entered. If the code was entered correctly, the display shows the "Lock 1 is opening" message, followed by "Lock is open". The display then shows the "Lock code 2" message to indicate that user code 1 or 2 for lock 2 (**12223310** or **12223320**) must be entered. If the code was entered correctly, the display shows the "Lock 2 is opening" message, followed by "Locks are open, open bolts". The rotary opening handle can only be moved clockwise after the second "Open bolts" message.
5. Open the door (display shows "Released").

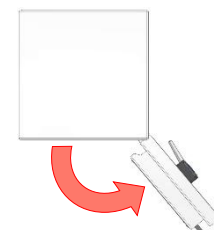
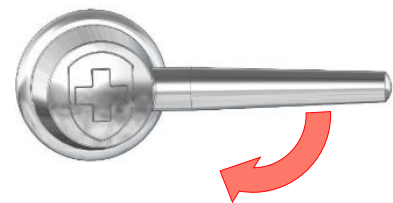
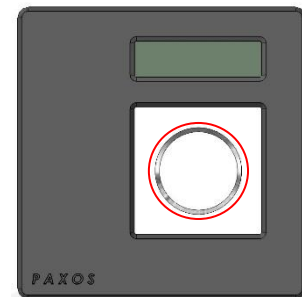

NOTE: Every movement of the rotary knob is acknowledged by an acoustic signal. If the interval between two numeric inputs is more than 25 seconds, the display switches off and you must input the entire code from the beginning again. If you make an incorrect entry, you can delete the entire code with the CLR key and re-enter your code.

3.2. Locking the safe

1. Close the door while the **rotary opening handle is in the "open" position**.

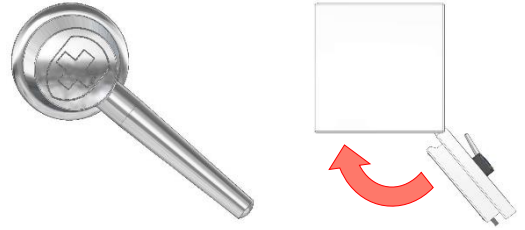

2. Turn the rotary opening handle counterclockwise into the "closed" position (lock closes automatically).

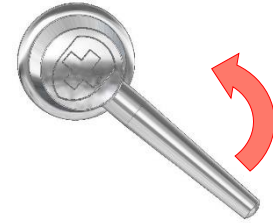

Wait for the "Lock closed!" message on the display.

3. Gently press the rotary opening handle clockwise to check whether the lock – and therefore the safe – are locked.



3.3. Opening the safe under threat

If the locking system is connected to an alarm installation, a silent alarm (which cannot be heard at your location) can be sent to the alarm centre when the code to open the safe is entered in the normal way. To trigger the threat alarm, the value of the **last two digits** of the opening code must be increased by three. This input sends an alarm and the lock opens (so as not to arouse suspicion).

Make sure that the threat code does not result in a valid opening code!

Explanation:

Last digits of the opening code:	Addition:	Input:
XXXXXX96	$96 + 3 = 99$	XXXXXX99
XXXXXX97	$97 + 3 = 100$	XXXXXX00
XXXXXX98	$98 + 3 = 101$	XXXXXX01
XXXXXX99	$99 + 3 = 102$	XXXXXX02
XXXXXX00	$00 + 3 = 03$	XXXXXX03
XXXXXX05	$05 + 3 = 08$	XXXXXX08

Examples:

Opening code:	Threat code:
19275339	19275342
19275342	19275345
19275398	19275301

3.4. Reprogramming codes



NOTE: A new code must always be programmed while the door is open so that the safe is not closed in case of an incorrect input, which would result in an incorrect code being programmed!

If the code has been forgotten or can no longer be reconstructed, an emergency opening of the safe must be performed and it must be repaired or replaced at the owner's expense!

The certification lapses in case of a repair.

The Paxos Advance lock contains two user codes and one master code. Up to 95 "employee codes" can be defined in addition. The following factory codes are programmed:

The following codes **must be changed**:

Lock 1:

User code 01 (**OCa1**): 11 22 33 10

User code 02 (**OCb1**): 11 22 33 20

Lock 2:

User code 01 (**OCa2**): 12 22 33 10

User code 02 (**OCb2**): 12 22 33 20

The following codes **can be changed**:

Master code 00 (**MA1**): 11 99 88 77

Master code 00 (**MA2**): 12 99 88 77

Battery code (BC94): 11 11 11 11

(The lock cannot be opened with this code; it is needed to define the "employee codes" and the time functions.)

The Paxos Advance electronic high-security lock is normally in "Sleep mode" (power-saving mode). The lock is activated by pressing the rotary knob.

3.4.1. User code 01 (OCa1) and user code 02 (OCb1) for lock 1



NOTE: It is essential to reprogramme the two user codes 1 and 2, because the two factory codes could be known to a third party and the safe could be opened.

Procedure:

1. Open the door with the current codes.
2. Leave the rotary opening handle in the "open" position.
3. Press the rotary knob on the input unit, and confirm the "Code functions" menu that is shown on the display by pressing the rotary knob again.
4. The display shows "Lock 1"; also confirm this with the ENTER key.
5. Turn the rotary knob to select "01 OCa1" / "02 OCb1" and confirm by pressing the rotary knob; the display shows "Change".
6. Confirm this by pressing the rotary knob and enter the existing code 1 (OCa1/ OCb1) (when you reprogramme for the first time, this is 11223310 for code 1 and 11223320 for code 2), and confirm by pressing the rotary knob.

7. Then enter the new code (8 digits) and confirm again by pressing the rotary knob.
8. Enter the new code again to confirm it, and press the rotary knob to complete the confirmation. The display shows: "Code saved".
9. With the door open, move the rotary opening handle counterclockwise into the "closed" position (lock closes automatically).
10. Enter the newly programmed code and open the lock again by moving the rotary opening handle clockwise.
11. If the test opening works, this guarantees that the new code has been saved and the door can be closed.



NOTE: If errors occur while making the change, the old code remains valid. You must start the programming procedure from the beginning again.

3.4.2. User code 01 (OCa2) and user code 02 (OCb2) for lock 2

Procedure:

1. Open the door with the current codes.
2. Leave the rotary opening handle in the "open" position.
3. Press the rotary knob on the input unit, and confirm the "Code functions" menu that is shown on the display by pressing the rotary knob again.
4. On the display, use the arrow key to select "Lock 2" and also confirm this with the ENTER key.
5. Turn the rotary knob to select "01 OCa2" / "02 OCb2" and confirm by pressing the rotary knob; the display shows "Change".
6. Confirm this by pressing the rotary knob and enter the existing code 1 (OCa2/ OCb2) (when you reprogramme for the first time, this is 12223310 for code 1 and 12223320 for code 2), and confirm by pressing the rotary knob.
7. Then enter the new code (8 digits) and confirm again by pressing the rotary knob.
8. Enter the new code again to confirm it, and press the rotary knob to complete the confirmation. The display shows: "Code saved".
9. With the door open, move the rotary opening handle counterclockwise into the "closed" position (lock closes automatically).
10. Enter the newly programmed code and open the lock again by moving the rotary opening handle clockwise.
11. If the test opening works, this guarantees that the new code has been saved and the door can be closed.

3.4.3. Master code 00 (MA1)



RECOMMENDATION: Use the same code for the master code and user code 01 (OCa1), or leave the master code on the factory setting (11998877). The safe cannot be opened with the master code on its own!

Procedure:

1. Open the door with the current codes.
2. Leave the rotary opening handle in the "open" position.
3. Press the rotary knob on the input unit, and confirm the "Code functions" menu that is shown on the display by pressing the rotary knob again.
4. Turn the rotary knob to select "Lock 1" and then "00 MA1"; confirm by pressing the rotary knob, and the display shows "Change".
5. Confirm this by pressing the rotary knob and then enter the existing lock code (MA1) (when you reprogramme for the first time, this is 11998877), and confirm by pressing the rotary knob.
6. Then enter the new code (8 digits) and confirm again by pressing the rotary knob.
7. Enter the new code again to confirm it, and press the rotary knob to complete the confirmation. The display shows: "Code saved".

3.4.4. Master code 00 (MA2)



RECOMMENDATION: Use the same code for the master code and user code 01 (OCa2), or leave the master code on the factory setting (12998877). The safe cannot be opened with the master code on its own!

Procedure:

1. Open the door with the current codes.
2. Leave the rotary opening handle in the "open" position.
3. Press the rotary knob on the input unit, and confirm the "Code functions" menu that is shown on the display by pressing the rotary knob again.
4. Turn the rotary knob to select "Lock 2" and then "00 MA2"; confirm by pressing the rotary knob, and the display shows "Change".
5. Confirm this by pressing the rotary knob and then enter the existing lock code (MA2) (when you reprogramme for the first time, this is 12998877), and confirm by pressing the rotary knob.
6. Then enter the new code (8 digits) and confirm again by pressing the rotary knob.
7. Enter the new code again to confirm it, and press the rotary knob to complete the confirmation. The display shows: "Code saved".

3.5. Setting the date and time

1. With the door open and the rotary opening handle in the "open" position, press the rotary knob; turn the rotary knob to select the "Time functions" menu, and confirm by pressing the rotary knob.
2. On the display, confirm the "Lock 1" menu by pressing the rotary knob.
3. Enter the master code (MA1) and confirm by pressing the rotary knob.
4. The display shows the "Date/time" menu, which you must confirm by pressing the rotary knob.
5. Use the rotary knob to enter the date and time, and confirm by pressing the rotary knob. The date and time are then saved.

3.6. Replacing the battery

1. Purchase the batteries (6 x 1.5 V AA alkaline batteries: LR6, E91 or AM3).

Note the expiration date!



2. Use your finger to release the battery case that is slotted into the input unit from below, and swivel it downwards and outwards.



3. The battery holder (B) is inserted in the battery case; release it from the case, and fit six 1.5 V AA alkaline batteries (LR6, E91 or AM3) into it. As an option, you can also insert a rechargeable battery pack (A) from Dorma Kaba; in this case, there is no need for the battery holder.

Pay attention to the polarity of the batteries!

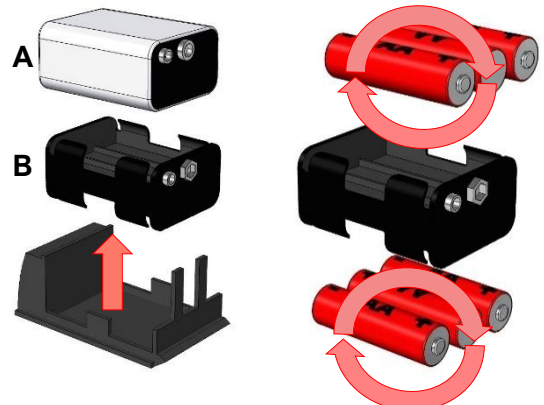

- ➔ Operation with rechargeable batteries is only possible with an external power supply.

- Carefully re-insert the battery holder (B) or the rechargeable battery pack (A) into the battery case.

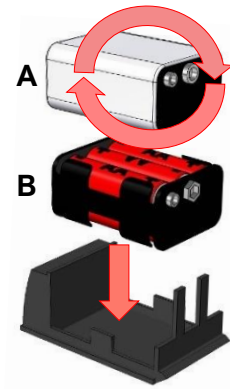

- Carefully re-insert the battery case and swivel it upwards into the housing of the input unit until the battery housing clicks into place.

As soon as the input unit is supplied with power, the display shows one of these messages: "Battery case was open, battery inserted" or "Battery case was open, rechargeable battery inserted".



- To delete the battery message, you must first press the rotary knob, then enter the master code (MA1) or the battery code (1111111), and confirm by pressing the rotary knob. The lock can then be used again in the normal way.

4. Malfunctions

4.1. Battery

If there is insufficient battery voltage, the display shows the "Battery flat" message.

If you observe the warning just mentioned, the battery for the lock must be replaced as quickly as possible (section 3.6.).

The lock can be operated until the battery voltage drops below 6.5 volts.

No codes or settings are deleted when a battery is replaced. You only need to check the date and time, and reset them if necessary (section 3.5.).



NOTE: Do not use rechargeable AA batteries (accumulator batteries) because they do not have enough capacity to ensure fault-free operation!

4.2. Tamper block

After 5 invalid code inputs, the rotary knob is blocked for 6 minutes. The remaining lockout time is shown on the display, and it cannot be bypassed. If the incorrect code is entered again after the lockout time has elapsed, the lockout time of 6 minutes will start again. From the tenth successive incorrect input onwards, the lock will block inputs for 20 minutes. The lockout time ends as soon as the valid code has been entered correctly.

5. Assignment of connections on the I/O box



NOTE: Installation and connection of the safe to an alarm or security system **must only be performed by trained specialist staff!**

5.1. Assignment of terminals on the I/O box

The I/O box has 8 inputs and 8 outputs, connections for the power supply, and an RS232 interface.



NOTE: The I/O box functions are only available when the I/O box is connected to an external power source. In case of a power outage, the batteries in the input unit guarantee the lock functions but not the functions of the I/O box.

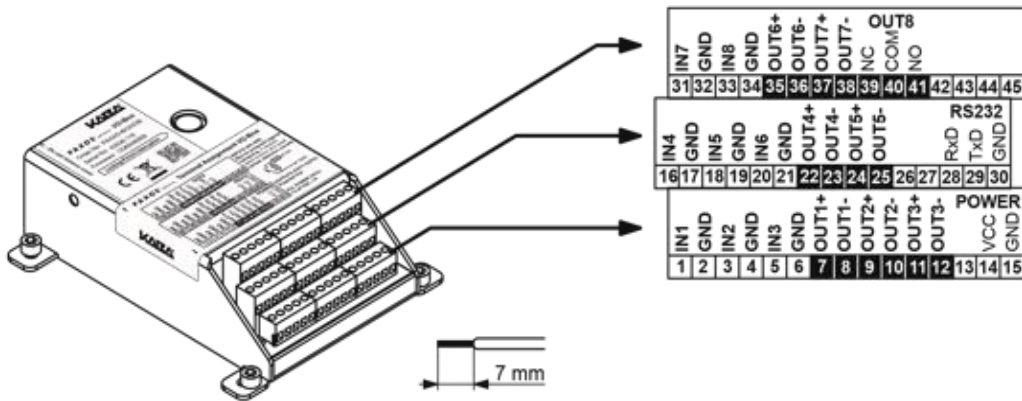

Klemmenbelegung I/O-Box

Assignment of terminals on the I/O box

5.2. Connection data for the I/O box

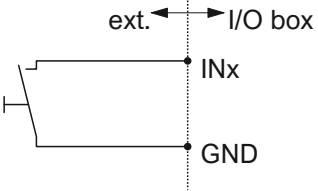
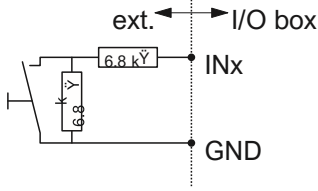
Terminal	Description	Capacity/comments
1 (IN1) / 2 (GND) **	Input 1 Standard: remote lockout	12 ... 24 VDC (min. 5 mA) * Connection without tamper monitoring switch (factory configuration):  ** Connection with tamper monitoring switch (factory configuration): 
3 (IN2) / 4 (GND) *	Input 2 Standard: bypass opening delay	
5 (IN3) / 6 (GND) *	Input 3 Standard: interrupt lockout time	
16 (IN4) / 17 (GND) *	Input 4 Standard: external tamper contact	
18 (IN5) / 19 (GND) *	Input 5 Standard: not assigned	
20 (IN6) / 21 (GND) *	Input 6 Standard: not assigned	
31 (IN7) / 32 (GND) *	Input 7 Standard: not assigned	
33 (IN8) / 34 (GND) *	Input 8 Standard: not assigned	

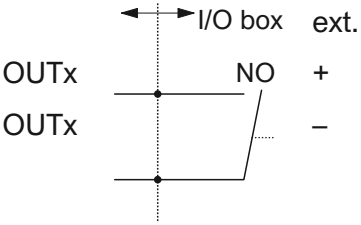
Terminal	Description	Capacity/comments
7 (OUT1+) / 8 (OUT1-)	Output 1 Standard: lock 1 open	Output voltage: 24 VAC Power load at output: 0.4 A at 25°C 0.3 A at 50°C 
9 (OUT2+) / 10 (OUT2-)	Output 2 Standard: all locks and door bolts open	
11 (OUT3+) / 12 (OUT3-)	Output 3 Standard: resistance monitoring input sabotaged	
22 (OUT4+) / 23 (OUT4-)	Output 4 Standard: external tamper input	
24 (OUT5+) / 25 (OUT5-)	Output 5 Standard: threat alarm impulse	
35 (OUT6+) / 36 (OUT6-)	Output 6 Standard: threat alarm with code	
37 (OUT7+) / 38 (OUT7-)	Output 7 Standard: battery case open	

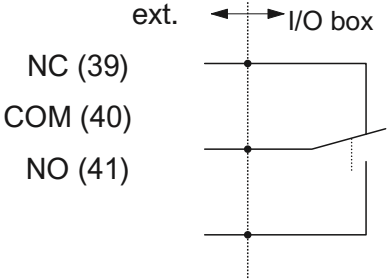
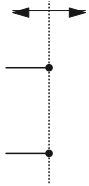
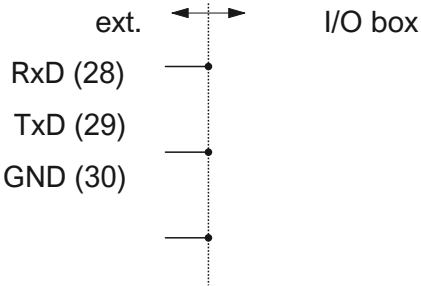
Terminal	Description	Capacity/comments
39 (NC) / 40 (COM) / 41 (NO)	Output 8 Standard: monitoring of external power supply	Output voltage: 24 VAC power load at output: 0.4 A at 25°C 0.3 A at 50°C 
14 (VDC) / 15 (GND)	External power supply	12 VDC ... 24 VDC 700 ... 200 mA ext. I/O box 12...24 VDC (14) GND (15) 
28 (RxD) / 29 (TxD) / 30 (GND)	Serial interface (e.g. for online logging)	

6. Basic rules for secure codes

What you should avoid:

- Don't use commonplace sequences such as 00000000 or 12345678.
- Do not use your own birthday or any car registration numbers, phone numbers or names (your own name or those of your spouse, children, pets, company, place where you live, etc.); the code should not have a logical structure.
- Do not use any standard passwords such as "password" or "safe".
- Writing backwards is also too simple.
- Don't use a password that you already use elsewhere.

Keeping a password secure:

- A password is only secure if it stays secret!
- You should memorise passwords – don't write them down.
- Think how the password would still be kept available in case the person who has it is no longer able to disclose it (e.g. if they die). Deposit a sealed envelope with your notary.



NOTE: If the password/code has been forgotten or can no longer be reconstructed, the safe must be drilled open and repaired or replaced at the owner's expense!